

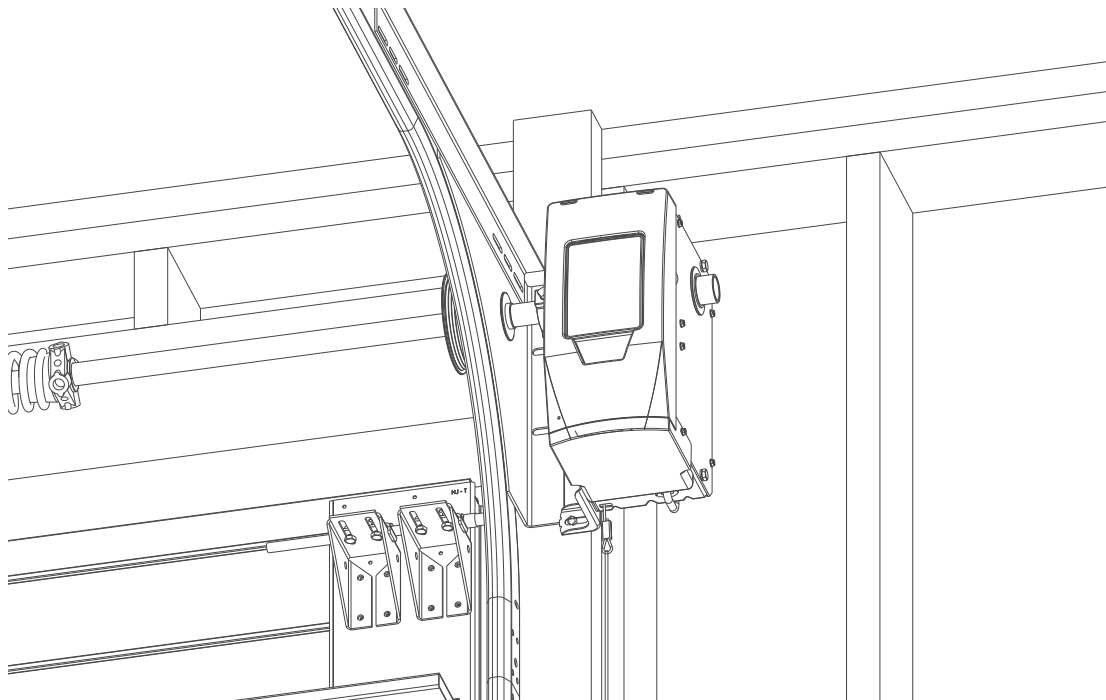

# RESIDENTIAL WALL MOUNT OPENER PROGRAMMING, OPERATION, TROUBLESHOOTING & MAINTENANCE MANUAL



**DO NOT** use photocells from other manufacturers or openers with this opener.

**INSTALLER: LEAVE THIS MANUAL WITH HOMEOWNER**

**HOMEOWNER: SAVE THIS MANUAL FOR FUTURE REFERENCE**

## **! WARNING**

To reduce the risk of injury to persons or damage to property, use this opener only with a residential sectional door with front torsion springs.

## **! AVERTISSEMENT**

Pour réduire le risque de blessures corporelles ou de dégâts matériels, utilisez cet ouvre-porte uniquement avec une porte sectionnelle résidentielle munie de ressorts de torsion avant.

SERIAL NUMBER DECAL

iDCM SERIAL NUMBER DECAL

# INDEX

Section	Information	Page
<b>1</b>	<b>Safety Notifications</b> .....	4
	<b>Important Installation Instructions</b> .....	5
<b>2</b>	<b>Apply Power to Opener:</b> Perform pre-operation systems check .....	6
<b>3</b>	<b>Programming Opener And Accessories:</b> Introduction .....	7
	Adjusting For Drum Selection .....	8
	Setting Down Limit.....	9
	Setting Up Limit.....	10
	Setting Force Control And Contact Reverse .....	11
	Programming Additional Remote Controls .....	12
	<b>Programming Accessories:</b> Wireless Keypad* .....	13
	Programming Vehicle Controls* .....	14-15
	Programming Aladdin Connect® .....	16-17
<b>4</b>	<b>Special Installation Information:</b> Power Input Alternatives .....	18
	Changing Force Settings .....	19
	Clearing Remote/Accessory Memory .....	20
	Locating Safe-T-Beam® (multiple doors) .....	21
	Safe-T-Beam® Troubleshooting .....	21
	Installing Battery Back Up .....	22
	Adding And Programming Additional Accessories .....	23
	Installing optional accessories .....	24
<b>5</b>	<b>User Maintenance:</b> Important Safety Instructions.....	26
	Regular Maintenance Schedule .....	27
	Door Inspection & Maintenance.....	27
	Remote Battery Replacement.....	27
<b>6</b>	<b>Troubleshooting &amp; LED Signals</b> .....	28-30
<b>7</b>	<b>Replacement Parts</b> .....	30-33
<b>8</b>	<b>DASMA Information</b> .....	34-35

## SAVE THESE INSTRUCTIONS

### READ AND FOLLOW ALL INSTRUCTIONS

#### FCC Part 15.21 Statement:

**Changes or modifications not expressly approved by the party responsible for compliance could void the user's authority to operate the equipment.**

#### FCC / IC Statement:

**This device complies with FCC Part 15 and Industry Canada licence-exempt RSS standard(s). Operation is subject to the following two conditions: (1) this device may not cause harmful interference, and (2) this device must accept any interference received, including interference that may cause undesired operation of the device.**

**Le présent appareil est conforme aux CNR d'Industrie Canada applicables aux appareils radio exempts de licence. L'exploitation est autorisée aux deux conditions suivantes : (1) l'appareil ne doit pas produire de brouillage, et (2) l'utilisateur de l'appareil doit accepter tout brouillage radioélectrique subi, même si le brouillage est susceptible d'en compromettre le fonctionnement.**

*\* Abbreviated versions. See instructions that accompany ACCESSORY or VEHICLE OWNERS MANUAL for full details, WARNINGS, CAUTIONS and instructions.*

Thank you for purchasing a Genie® brand garage door opener. The leader in garage door opener technology.

Please take a moment to preview this manual and assembly poster to ensure that you have the proper tools and general assembly and fabrication skills required to install a new garage door opener.

Read and understand all **SAFETY WARNINGS** and **CAUTIONS** contained in this manual before proceeding.



**DO NOT RETURN PRODUCT TO STORE**

*If you require assistance or have any questions, a knowledgeable Genie Service Technician is just a phone call away at:*

**1-800-35-GENIE (1-800-354-3643)**

*Or visit our website at:*

**[www.geniecompany.com](http://www.geniecompany.com)**

Before setting up your new garage door opener, please note the model plate on the opener and serial number(s) located on the front of this manual. This information will be necessary should you seek technical support via our website, customer support department or local servicing Genie dealer.

Spanish language manuals available at:

Idioma alternativo manuales disponibles en:



**[www.geniecompany.com](http://www.geniecompany.com)**

# SAFETY NOTIFICATIONS & INSTRUCTIONS

## OVERVIEW OF POTENTIAL HAZARDS

### READ THIS SAFETY INFORMATION

Garage doors are large, heavy objects that move with the help of springs under high tension and electric motors. Since moving objects, springs under tension, and electric motors can cause injuries, your safety and the safety of others depend on you reading the information in this manual. If you have questions or do not understand the information presented, call your nearest trained door system technician or visit our website at [www.geniecompany.com](http://www.geniecompany.com)

### CONVENTIONS USED IN THESE INSTRUCTIONS

The following safety alert symbol and signal words are used throughout this manual to call attention to and identify different levels of hazards and special instructions.

This is the safety alert symbol. This symbol alerts you to potential hazards that can kill or hurt you and others. All safety messages will follow the safety alert symbol and the word "DANGER", "WARNING", or "CAUTION".



- **DANGER** indicates an imminently hazardous situation which, if NOT avoided, will result in death or serious injury.
- **WARNING** indicates a potentially hazardous situation which, if NOT avoided, could result in death or serious injury.
- **CAUTION** indicates a potentially hazardous situation which, if NOT avoided, may result in injury or property damage.
- The word **NOTE** is used to indicate important steps to be followed or important considerations.

Tous les messages concernant la sécurité seront indiqués après un symbole d'alerte de la sécurité et l'une des mentions suivantes "DANGER", "AVERTISSEMENT" ou "MISE EN GARDE".



- **DANGER** signale une situation dangereuse imminente qui, si elle n'est pas évitée, risque d'entraîner des blessures graves, voire mortelles.
- **AVERTISSEMENT** signale une situation potentiellement dangereuse qui, si elle n'est pas évitée, risque d'entraîner la mort ou des blessures graves.
- **MISE EN GARDE** signale une situation potentiellement dangereuse qui, si elle n'est pas évitée, risque d'entraîner des blessures ou des dommages matériels.
- Le terme **REMARQUE** est utilisé pour signaler les étapes importantes à suivre ou d'importants éléments à prendre en considération.

## IMPORTANT SAFETY INSTRUCTIONS

POTENTIAL HAZARD	EFFECT	PREVENTION
<p><b>MOVING DOOR</b></p>	<p><b>WARNING</b> Could result in Serious Injury or Death</p>	Do Not operate unless the doorway is in sight and free of obstructions. Keep people clear of opening while door is moving. Do Not allow children to play with the door opener. Do Not change opener control to momentary contact unless an external reversing means is installed. Do Not operate a door that jams or one that has a broken spring.
<p><b>ELECTRICAL SHOCK</b></p>	<p><b>WARNING</b> Could cause Serious Injury or Death</p>	Turn off electrical power before removing opener cover. When replacing the cover, make sure wires are not pinched or near moving parts. Opener must be electrically grounded.
<p><b>HIGH SPRING TENSION</b></p>	<p><b>WARNING</b> Could cause Serious Injury or Death</p>	Do Not try to remove, repair or adjust springs or anything to which door spring parts are fastened such as wood block, steel brackets, cables or any other structure or like item. Repairs and adjustments must be made by a trained service representative using proper tools and instructions.

## IMPORTANTES CONSIGNES DE SÉCURITÉ

DANGER POTENTIEL	EFFET	PRÉVENTION
<p><b>PORTE EN MOUVEMENT</b></p>	<p><b>AVERTISSEMENT</b> Pourrait entraîner des blessures graves voire la mort</p>	Utiliser uniquement si la porte est en vue et libre de tout obstacle. Ne laisser personne se tenir dans l'ouverture de la porte pendant qu'elle est en mouvement. Ne pas permettre aux enfants de jouer avec l'opérateur de la porte. Ne pas modifier la commande de l'opérateur à contact momentané à moins qu'un moyen d'inversion externe soit installé. Ne pas faire fonctionner une porte qui bloque ou dont le ressort est cassé.
<p><b>CHOC ÉLECTRIQUE</b></p>	<p><b>AVERTISSEMENT</b> Pourrait entraîner des blessures graves voire la mort</p>	Couper le courant avant d'enlever le couvercle de l'opérateur. Lorsque le couvercle doit être remplacé, s'assurer que les fils ne sont ni coincés ni près des pièces mobiles. L'opérateur doit être correctement mis à la terre.
<p><b>TENSION ÉLEVÉE RESSORT</b></p>	<p><b>AVERTISSEMENT</b> Pourrait entraîner des blessures graves voire la mort</p>	Ne pas essayer d'enlever, réparer ni ajuster les ressorts ou toute autre pièce à laquelle le ressort de la porte est attaché, y compris blocs de bois, supports en acier, câbles ou autres articles semblables. Les réparations et les réglages doivent être effectués par technicien qualifié qui se sert d'outils appropriés et qui respecte les instructions.

# IMPORTANT INSTALLATION INSTRUCTIONS



## WARNING

### TO REDUCE THE RISK OF SEVERE INJURY OR DEATH

READ AND FOLLOW ALL SAFETY, INSTALLATION AND OPERATION INSTRUCTIONS. If you have any questions or do not understand an instruction, call The Genie® Company.

- READ AND FOLLOW ALL SAFETY, INSTALLATION AND OPERATION INSTRUCTIONS. If you have any questions or do not understand an instruction, call The Genie® Company.
- DO NOT install opener on an improperly balanced door. An improperly balanced door could cause severe injury. Repairs and adjustments to cables, spring assembly and other hardware must be made by a trained service person using proper tools and instructions.
- Remove all pull ropes, and disable all locks connected to the door before installing opener.
- Where possible, install the door opener 7 ft, (2.14m) or more above the floor. For products having an emergency release, mount the emergency release within reach, but at least 6 ft. (1.83m) above the floor and avoiding contact with vehicles to avoid accidental release.
- DO NOT connect the opener to the source of power until instructed to do so.
- Locate the Wall Control: (a) within sight of the door, (b) at a minimum height of 1.53 m (5 ft) above floors, landings, steps or any other adjacent walking surface so small children are not able to reach it, and (c) away from all moving parts of the door.
- Install the entrapment WARNING label next to the wall button or console, in a prominent location. Install the emergency release handle on the emergency release cord.
- The opener must reverse when the door contacts a 1-1/2 in. (38mm) high object on the floor at the center of the doorway. This is about the size of a 2" x 4" board laid flat.
- For products having a manual release, instruct the end user on the operation of the manual release.

# IMPORTANTES INSTRUCTIONS D'INSTALLATION



## AVERTISSEMENT

### POUR RÉDUIRE LES RISQUES DE BLESSURES GRAVES VOIRE MORTELLES

LIRE ET SUIVRE ATTENTIVEMENT TOUTES LES INSTRUCTIONS D'INSTALLATION ET DE FONCTIONNEMENT AINSI QUE TOUTES LES CONSIGNES DE SÉCURITÉ. Si vous avez des questions ou si vous ne comprenez pas une instruction, veuillez contacter directement The Genie® Company.

- NE PAS installer l'opérateur sur une porte mal équilibrée. Celle-ci pourrait entraîner de graves blessures. Les réparations et les réglages des câbles, ensembles de ressort ou tout autre article de quincaillerie doivent être effectués par un professionnel qui se sert d'outils appropriés et qui respecte les instructions.
- Enlever toutes les cordes et désactiver toutes les verrous de la porte avant l'installer l'opérateur.
- Dans la mesure du possible, installer l'ouvre-porte à 2,1 m ou plus au-dessus du sol. Pour les produits dotés d'un cordon de déclenchement d'urgence, installer le déclenchement d'urgence mais au moins à 1,8 m au-dessus du sol en évitant tout contact avec les véhicules pour éviter qu'ils ne soient déclenchés accidentellement. NE PAS connecter l'opérateur à la source d'alimentation tant que l'instruction n'est pas donnée.
- Installez le bouton de commande a) à un endroit que l'on peut voir de l'embrasure de la porte; b) à une hauteur minimale de 1,53 m (5 pi) du sol — afin que les jeunes enfants ne puissent pas l'atteindre ; et c) à l'écart des
- Pièces mobiles de la porte.
- Placer l'étiquette d'AVERTISSEMENT en cas de coinçage à proximité du bouton mural ou de la console de manière à ce qu'elle soit bien en évidence. Installer la poignée du cordon de déclenchement d'urgence.
- L'opérateur doit s'inverser lorsque la porte entre en contact avec un objet d'une hauteur de 3,8 cm placé sur le sol, au centre de l'ouverture de la porte. Ceci équivaut environ à une planche de 5 x 10 cm posée à plat sur le sol.
- Pour les produits à libération manuelle, informez l'utilisateur final sur le fonctionnement de la libération manuelle.

## APPLYING POWER TO THE OPENER



### WARNING

Opener is equipped with grounded electrical plug for your protection, and only fits grounded electrical outlets. DO NOT alter plug in any way! If you have no grounded outlets, have one installed by a licensed electrician. Opener must be properly grounded to prevent personal injury and equipment damage. NEVER USE AN EXTENSION CORD! Check local building codes for any requirement that you must have a permanent hard-wired connection.



### AVERTISSEMENT

L'opérateur, qui est équipé d'une prise électrique mise à la terre pour votre protection est compatible uniquement avec des prises électriques mises à la terre. NE PAS modifier la fiche d'une quelconque manière. Si vous n'avez pas de prises mises à la terre, faites-en installer par un électricien agréé. L'opérateur doit être correctement mis à la terre pour éviter les blessures corporelles et des dommages matériels. NE JAMAIS UTILISER DE RALLONGE! Vérifiez les codes locaux des bâtiments pour connexions câblées permanente. Les connexions câblées permanentes doivent être effectuées par un électricien agréé qui se servira d'outils appropriés et respectera les consignes.



### CAUTION

**DO NOT** run opener until travel limits have been set to avoid damage to unit.



### CAUTION

NE PAS faire fonctionner l'ouvre-porte au-delà des limites de parcours pour ne pas endommager l'unité.

## Apply power to opener

### FOR GROUNDED OUTLET OR ALTERNATE POWER INPUT KIT CONNECTION:

Plug in the power cord to standard 115 VAC outlet.

DO NOT USE EXTENSION CORDS TO POWER THIS OPENER.

### FOR DIRECT POWER INPUT CONNECTIONS :

Turn on designated breaker to power opener.

### SYSTEM CHECK :

- DO NOT operate opener from remote control or wireless wall console until drum size, limit settings, force profile and contact reverse is set.
- Check LED lights on Safe-T-Beam system for proper operation (See troubleshooting section on page XX if LEDs do not light solid).

### 3 OPENER PROGRAMMING & ACCESSORY INSTALLATIONS

**NOTE:** Before programming the opener, check to make sure there are no objects in the garage door opening. DO NOT allow persons to enter the area of the door while programming and operating.

The following steps list the order of programming the opener's functional settings as well as installation of any accessories that were included with the opener or purchased separately. **These steps should be performed in order.**

1. Adjust opener speed for drum sizes.
2. Down Travel Limit
3. Up Travel Limit
4. Force Control
5. Contact Reverse test and adjustment
6. Remote Control Programming
7. Remote control(s), Lighting fixture and Wireless Wall Console included with this opener are programmed at the factory. The information provided on these pages should be used if adding additional remote controls, wireless wall consoles or light fixtures.
8. Accessory Installation and/or Programming
9. Program wireless keypad (If applicable)
10. Program built in vehicle remote (If applicable)
11. Program the Integrated Aladdin Connect™ (If applicable)
12. Install Battery Backup (BBU) (If applicable)

**NOTE:** When opener is activated to close, opener will start and stop slowly in small increments to detect cable tension then run at normal speed to close. This is normal operation.

Programming Button Layout

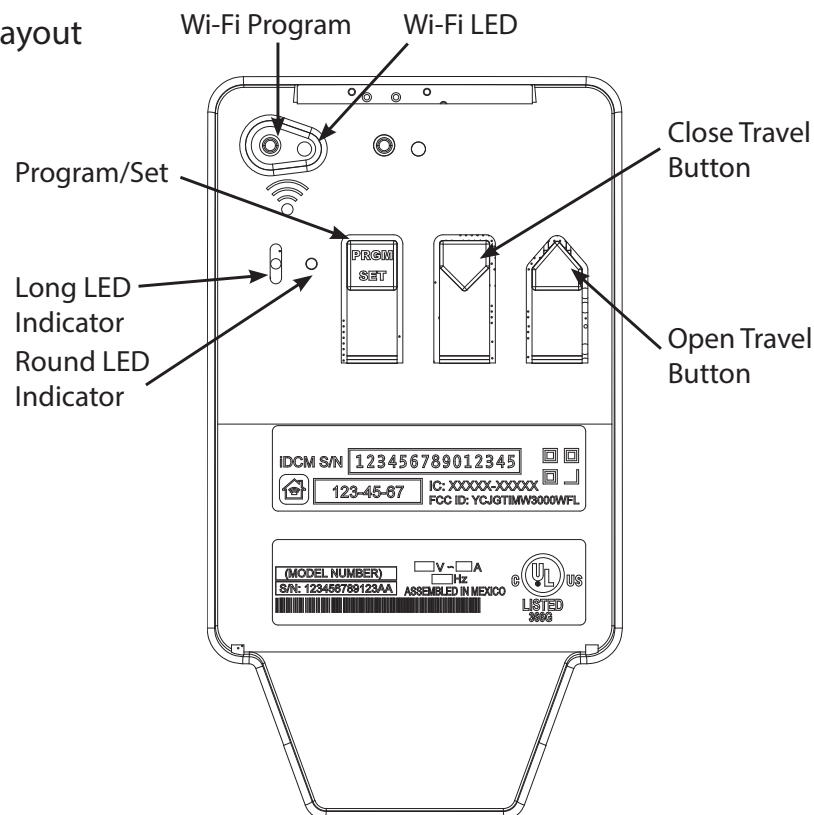

**NOTE:** Each programming step has a 30 second time limit for completion after the function is initiated. After 30 seconds, both LED's will illuminate RED indicating time has expired and the step must be restarted. Restart the step as many times as necessary to complete the programming.

# ADJUSTING FOR DRUM SELECTION

## ⚠ WARNING

Operator drum selection settings must be adjusted for use on Standard or High Lift residential doors with drum diameters greater than 4 inches. Drum selection settings must also be adjusted for use on residential Vertical Lift doors.

## ⚠ AVERTISSEMENT

Les réglages de sélection du tambour par l'opérateur doivent être ajustés pour une utilisation sur des portes résidentielles à levage régulier ou élevé avec des diamètres de tambour supérieurs à 4 pouces (10,16 cm). Les réglages de sélection du tambour doivent également être ajustés pour une utilisation sur des portes résidentielles à levage vertical.

### Drum Selection Settings

Drum selection settings are pre-programmed at the factory for 4" Standard Lift type drums. Drum selection must be made on doors with Standard or High Lift drums with a diameter greater than 4 inches, and also on Vertical Lift doors. There are two drum settings available for sectional doors. Please note that door speed may be affected by door weight, drum type, and balance, along with condition of door components and tracks. Proper selection of the drum type is important for proper operation of the opener.

### TO CHANGE OPENER drum selection:

1. Press and hold the SET/PRGM button on the opener until both LEDs turn BLUE then release.
2. Press the UP button twice.
3. Press PRGM button once.
4. The current setting will now be displayed. (SEE CHART).
5. Press either UP or DOWN buttons to adjust setting (SEE CHART)
6. Press PGRM button once to lock in the selection. LEDs turn BLUE then off.
7. Opener is now ready to set limits.

## ⚠ IMPORTANT NOTICE ⚠

**IF DRUM SELECTION SETTING IS ALTERED, ALL FOLLOWING STEPS ON PAGES 18 THROUGH 20 MUST BE PERFORMED TO LOCK IN THE FORCE PROFILE FOR PROPER DOOR OPERATION.**

DRUM SELECTION CHART

DRUM TYPE	Long LED	Round LED
Standard 4 inch or less diameter drum	RED	RED
Standard or High Lift greater than 4 inch diameter or Vertical Lift	PURPLE	PURPLE

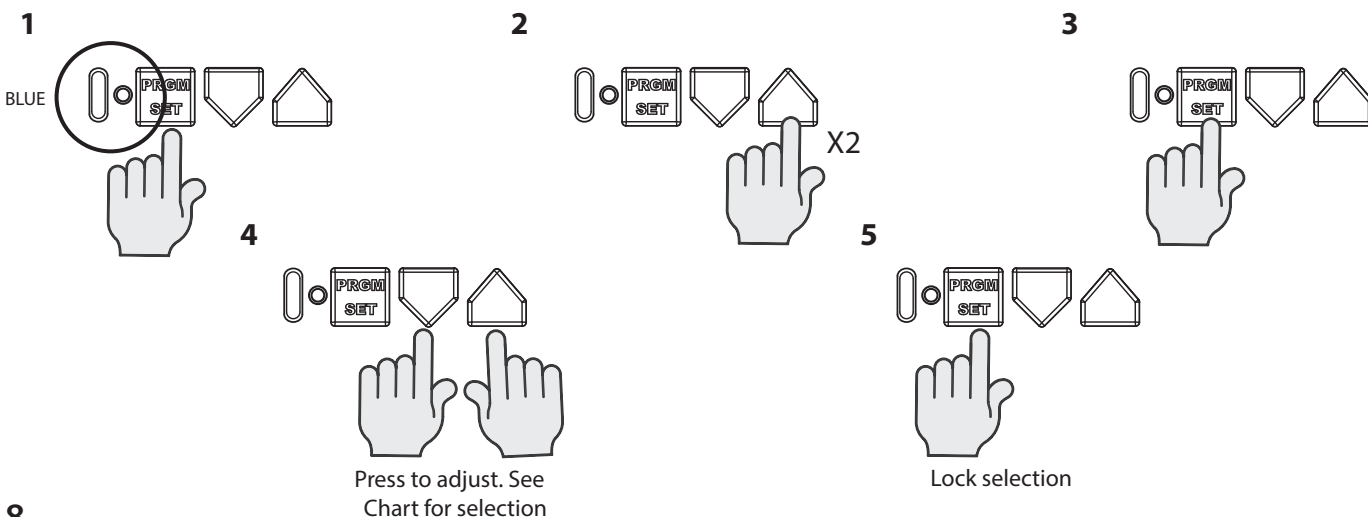



# PROGRAMMING THE DOWN LIMIT

## ⚠ WARNING

- Make sure doorway is in full view and clear of obstacles and people to avoid injury or property damage.
- DO NOT operate this unit from the wall control before LIMITS are set. Severe damage to the opener could occur.
- DO NOT set limits with Battery Backup attached. AC power MUST be connected to the opener while setting limits for proper operation.

**⚠ NOTE:** Door MUST be engaged to the opener prior to programming. Door should rest somewhere between full open and closed. **DO NOT START WITH DOOR FULLY OPEN OR CLOSED.**

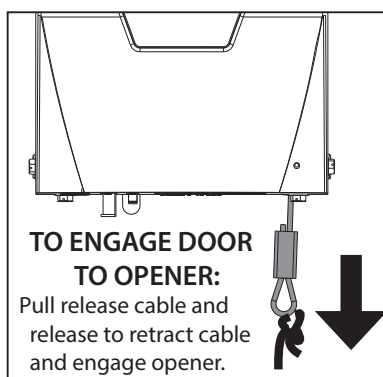

## Programming DOWN Limit:

1. Press and hold the DOWN arrow button on the opener for 2-5 seconds.
  - The LONG LED will turn BLUE. Release button.
  - The LONG LED will then flash BLUE.
2. Press and hold the DOWN arrow button until door is fully closed.  
Use both UP and DOWN buttons to adjust close travel as necessary.

*Door should rest on the floor until the weather strip is compressed enough to seal along the width of the door. Damaged doors or uneven floors may not seal properly. Repair these conditions to achieve a proper seal. DO NOT compress seal so much that the door will bend or buckle.*

3. Press and release the SET/PRGM button  
Both LEDs will flash BLUE then go out.

The DOWN limit is now programmed.

## ⚠ AVERTISSEMENT

- S'assurer que le passage de la porte est visible et dégagé, à savoir sans obstacles ni personne afin d'éviter toute blessure potentielle ou dommage matériel.
- NE PAS utiliser cette unité avec la console murale avant d'avoir réglé les LIMITES. L'ouvre-porte pourrait subir de sérieux dommages.
- NE PAS fixer de limites en mode batterie de secours. L'alimentation CA DOIT être branchée sur l'ouvre-porte, pendant le réglage des limites, pour assurer un bon fonctionnement.

### 1-2. Enter Programming Mode

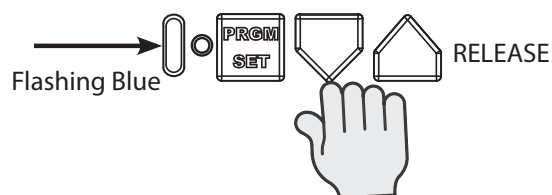
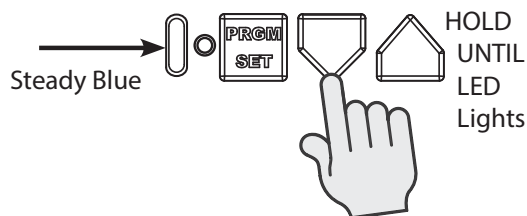

### 3. Adjust Door Position

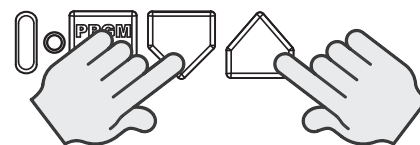

### 4. Lock Programming

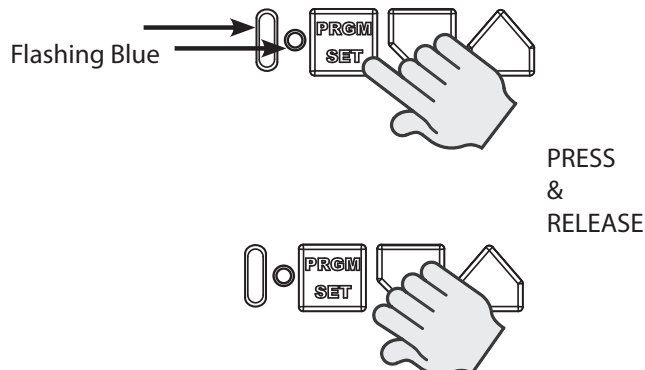

## ⚠ IMPORTANT NOTICE ⚠

**IF DOWN LIMIT SETTING IS ALTERED, ALL FOLLOWING STEPS ON PAGES 19 THROUGH 20 MUST BE PERFORMED TO LOCK IN THE FORCE PROFILE FOR PROPER DOOR OPERATION.**

# PROGRAMMING THE UP LIMIT

## Programming UP Limit:

1. Press and hold the UP arrow button on the opener for 2-5 seconds.
  - The LONG LED will turn BLUE. Release button.
  - The ROUND LED will then flash BLUE.
2. Press and hold the UP arrow button until door is fully open. Use both UP and DOWN buttons to adjust open travel as necessary.
3. Press and release the SET/PRGM button  
Both LEDs will flash BLUE then go out.

### SECTIONAL DOOR UP LIMIT:

Door should fully open so that door seal is about even with door header. Do not adjust so much that the door will bend, buckle or stretch door spring cables backward.

**The UP limit is now programmed.**

## 1-2. Enter Programming Mode

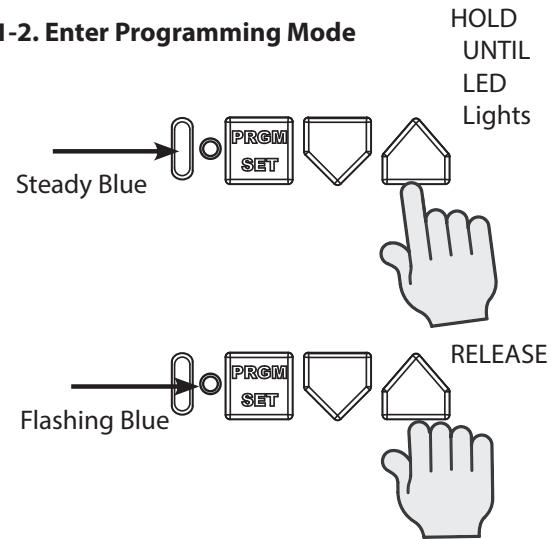

## 3. Adjust Door Position

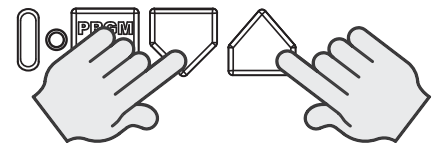

## 4. Lock Programming

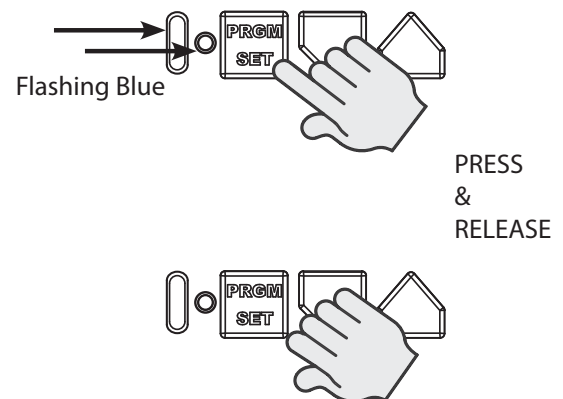

### ⚠ IMPORTANT NOTICE ⚠

IF UP LIMIT SETTING IS ALTERED, ALL FOLLOWING STEPS ON PAGE 20 MUST BE PERFORMED TO LOCK IN THE FORCE PROFILE FOR PROPER DOOR OPERATION.

# PROGRAMMING FORCE PROFILE & CONTACT REVERSE

## ⚠ IMPORTANT NOTICE ⚠

**THIS STEP MUST BE PERFORMED FOR PROPER OPERATION!**

- Operate opener 2 full cycles up and down to set new opener profile.

## ⚠ WARNING

### TO AVOID INJURY OR DAMAGE

**NEVER** adjust the force settings to adjust for damage, including an unbalanced door, binding door track or broken spring.  
Perform a CONTACT REVERSE TEST monthly.

## ⚠ AVERTISSEMENT

### Pour éviter les blessures ou des dommages

**NE JAMAIS** régler la force pour compenser des dommages, y compris une porte mal équilibrée, un rail de porte coincant ou des ressorts cassés.  
Tous les mois, EFFECTUEZ LE TEST D'INVERSION AU CONTACT.

## SETTING FORCE PROFILE

1. Press and release the Wall Control button and allow the garage door to travel and stop at the DOWN limit.
2. Press and release the wall control button and allow the garage door to travel and stop at the UP limit.
3. Repeat steps 1 and 2 to complete this setting.

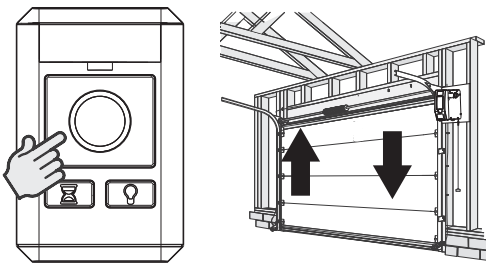

## Force Control Adjustments

Force settings are programmed from the factory to remain within safe parameters. These should not require adjustments. However, certain circumstances may require adjustment.

Refer to page 27 to adjust the force settings.

## Contact Reverse Test

**NOTE:** The limit and Force settings **MUST BE COMPLETED** before performing the Contact Reverse Test.

1. With the garage door open, lay a 2 X 4 board flat on the floor at the center of the door opening.
2. Close the garage door using the wall control.

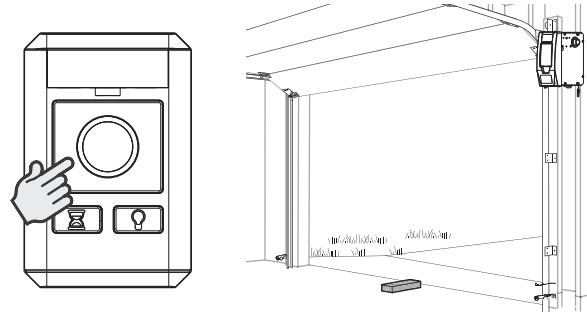

- When the door contacts the board, it should stop and reverse direction within 2 seconds to the full open position.
- The long LED light on the powerhead will begin to flash RED with the reversal of the door.
- Remove the 2" x 4" board and operate the opener with the wall control again. This cycle will clear the flashing red LEDs.

## Contact Reverse Adjustment

If the door stops before contacting the board or if it does not reverse direction to fully open after contact with the board, it may be due to an improperly set DOWN limit.

Verify settings by:

1. Repeat "Programming the Down Limit" section to make certain the door is closing tight against the floor.
2. Repeat the "Force Control" section on the left to set force limits.
3. Repeat the "Contact Reverse Test" above.

Repeat this process as needed until the door passes the Contact Reverse Test.

Refer to page 27 to adjust the force settings.

# PROGRAMMING ADDITIONAL REMOTE CONTROLS

**THE REMOTE CONTROLS INCLUDED WITH THIS OPENER HAVE BEEN PROGRAMMED AT THE FACTORY FOR YOUR CONVENIENCE.**

**NOTE:** The following instructions are for remote control transmitters purchased separately (In addition to those provided with this opener) but can also be used if remote(s) require re-programming.

**NOTE:** Each programming step has a 30 second time limit for completion after the function is initiated. After 30 seconds, two LED's will illuminate RED indicating time has expired and the step must be re-started. Restart the step as many times as necessary to complete the programming.

**NOTE:** Each button on each remote must be programmed separately, following these steps.

1. Remove the battery's protective film from the remote by pulling straight down.
2. Press and hold the SET/PRGM button on the opener for 2-5 seconds.
  - The ROUND LED will turn BLUE. Release button.
  - The LONG LED will then flash PURPLE.
3. Stand at least 5 feet away from opener and slowly press and release the desired button on the remote two times.  
Both opener LEDs will flash and turn off indicating the remote has been programmed.
4. Press the desired remote button again.  
The opener should run.

To program the same remote for other garage door openers, repeat the steps above using one of the other remaining remote buttons.

## REPEAT STEPS 1 TO 4 FOR EACH OPENER AND REMOTE

**NOTE:** It is possible to press the remote button too quickly or lightly. If the LEDs do not go off, press the remote button several more times to achieve confirmation.

**BASIC PROGRAMMING IS COMPLETE AND YOUR GARAGE DOOR OPENER IS READY TO USE.**

See page 28 of this manual to erase remote devices from memory.

## 1. Activate Remote



## 2. Enter Programming Mode

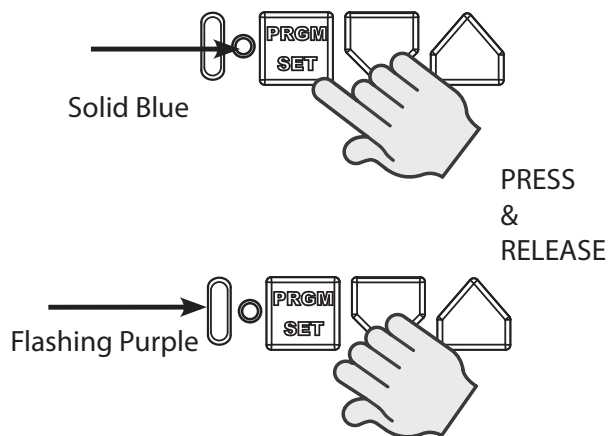

## 3. Press Remote Button Twice

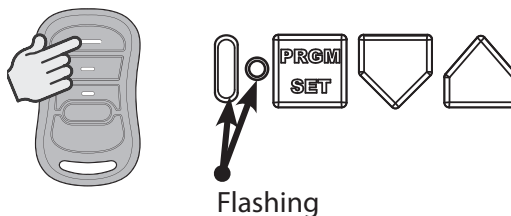

## 4. Test Remote

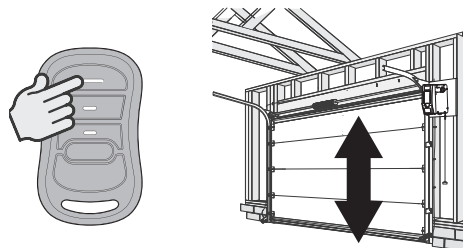

# PROGRAMMING ACCESSORIES (ABBREVIATED)

## QuickView Single Door setup.

Please see complete instructions that accompany keypad

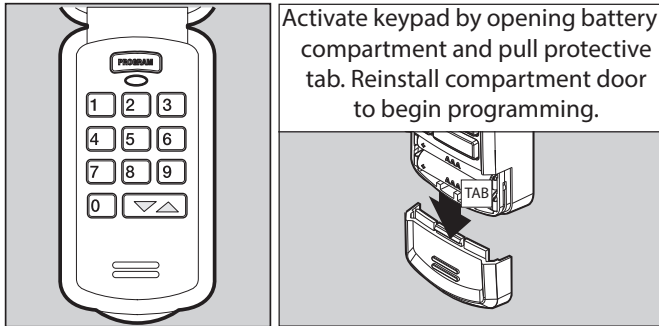

## Program Keypad before mounting.

### STEP 1) PROGRAMMING A PIN NUMBER (Single Door)

Program the keypad for the first time\* with a Personal Identification Number (PIN). This PIN must be 3 to 8 digits.

1. Ensure number pad back lighting is off.
2. Press 3-5-7 in sequence.
3. Press PROGRAM key. LED will blink once per second.
4. Enter a PIN number (3-8 digits).
5. Press PROGRAM key. LED will blink twice and shut off.

### STEP 2) PROGRAMMING THE KEYPAD TO 1 OPENER

1. Place garage door opener into PROGRAMMING MODE.
2. Ensure number pad back lighting is off.
3. Enter the PIN number on keypad.
4. Press the UP/DOWN key 3 to 4 times slowly until garage door opener operates.

### PUTTING OPENER INTO PROGRAMMING MODE:

1. Press and hold the SET/PRGM button on the opener for 2-5 seconds.
  - The ROUND LED will turn BLUE. Release button.
  - The LONG LED will then flash PURPLE.
2. Complete programming steps.

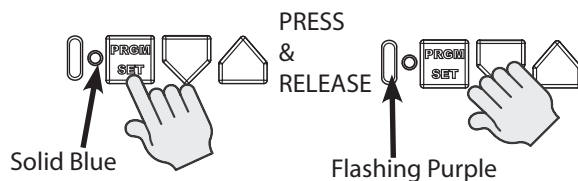

**NOTE:** The openers LEARN LED will time out in 30 seconds. Programming must be completed within 30 seconds.

### STEP 3) OPERATING THE KEYPAD WITH THE OPENER

#### Single Door Operation:

1. Ensure number pad back lighting is off.
2. Enter PIN number.
3. Press the UP/DOWN key.
4. Opener will operate.

**NOTE:** Keypad will remain active for 15 seconds after a successful entry is made. During this 15 seconds ANY key will operate the opener.

#### Resetting a PIN:

Press and hold both the **PROGRAM** key and the Up/Down key for about five seconds.

The LED's will slowly blink and then go out. When the LED stops blinking, the old programming has been successfully erased.

To create a new PIN go to STEP 1-Programming a PIN number.

### Mounting Keypad

The keypad **MUST** be mounted within sight of the garage door(s) at least five feet above the floor and clear of any moving door part.

1. Remove battery cover and batteries.
2. Drill 3/32" pilot hole for the top mounting screw (included).

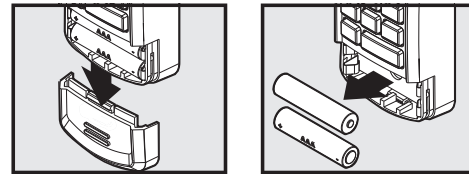

3. Install a screw into the pilot hole, leaving a 1/8" gap between the screw head and wall.
4. Hook the slotted mount, on back of keypad, over the screw.

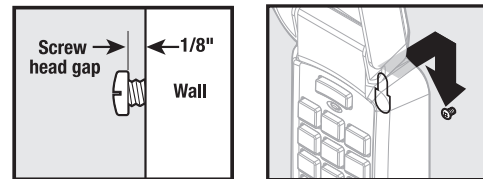

5. Mark and drill a pilot hole for the bottom screw (included)

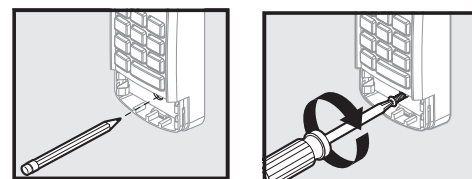

- and secure keypad to wall (DO NOT overtighten).
6. Reinstall batteries and cover.

# PROGRAMMING VEHICLE CONTROLS (ABBREVIATED)

## Programming HomeLink® System

### Step 1 Clear HomeLink

Clear HomeLink by pressing and holding down the first and third buttons until the indicator on the HomeLink blinks slow and then fast for 22 seconds; then release both buttons.

**NOTE:** Clearing the HomeLink will remove all previously programmed garage door openers.

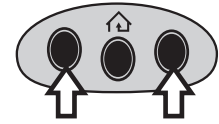

### Step 2 Train HomeLink to the Remote

Choose the button on the HomeLink that will be used to open the door.

**NOTE:** Hold the Remote two inches from the HomeLink button.

Hold down the remote button. While holding, press and hold the chosen HomeLink button.

Hold down both buttons until the indicator on the HomeLink blinks slow then fast. Once it blinks, release both buttons.

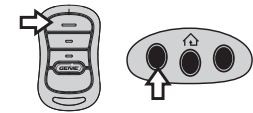

### Step 3 Program HomeLink to the Opener (Place opener into programming mode)

A. Press and hold the **PRGM** button on the opener until the round blue LED is ON. Release the button. The long purple LED will begin flashing.

**PUTTING OPENER INTO PROGRAMMING MODE:**

1. Press and hold the SET/PRGM button on the opener for 2-5 seconds.
  - The ROUND LED will turn BLUE. Release button.
  - The LONG LED will then flash PURPLE.
2. Complete programming steps.

**NOTE:** The openers LEARN LED will time out in 30 seconds. Programming must be completed within 30 seconds.

B. Press the chosen HomeLink button for two seconds and release. Press that same button again for two seconds and release. The both LEDs will flash blue and then turn off.

C. Press the HomeLink button a few more times until door moves.

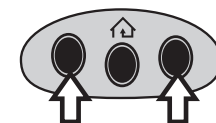

**NOTE:** For additional instructions, see the motor vehicle manual, [www.homelink.com](http://www.homelink.com) or visit [www.geniecompany.com](http://www.geniecompany.com)

# PROGRAMMING VEHICLE CONTROLS (ABBREVIATED)

## Programming Car2U<sup>®</sup> System

### Step 1 Clear Car2U to default settings

The default setting for the Car2U system is:

- Button 1 = Overhead Door™ & Genie® Manufactured Openers
- Button 2 = LiftMaster® Manufactured Openers
- Button 3 = Wayne Dalton® Manufactured Openers

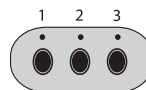

- A. Press and hold buttons 1 and 3 for 22 seconds or until all three LEDs begin to flash.
- B. Release both buttons. The Car2U system is now set to the Factory Default settings

**NOTE:** Clearing the Car2U remote will remove all previously programmed garage door openers.

### Step 2 Program Car2U to the Opener (Place opener into programming mode)

- A. Press and hold the **PROGRAM** button on the opener until the round blue LED is ON — release the button. The long purple LED will begin flashing.
- B. Press the designated Car2U button for two seconds and release. Press that same button again for two seconds and release. The long LED will flash blue and then turn off.
- C. Press the Car2U button a few times more until door moves.

#### PUTTING OPENER INTO PROGRAMMING MODE:

1. Press and hold the SET/PRGM button on the opener for 2-5 seconds.
  - The ROUND LED will turn BLUE. Release button.
  - The LONG LED will then flash PURPLE.
2. Complete programming steps.

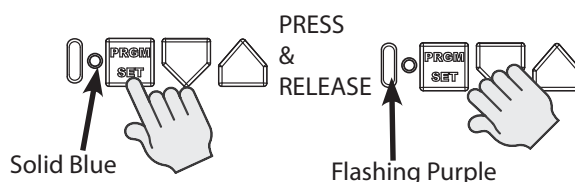

**NOTE:** The openers LEARN LED will time out in 30 seconds. Programming must be completed within 30 seconds.

### Step 3 Changing Factory Default Button for a Genie® or Overhead Door™ Opener

- A. Press and hold buttons 1 & 3 for **ONE SECOND** and release all three LEDs will light solid red.
- B. Press and hold the button (2 or 3) to change it to a **Genie® or Overhead Door™ Opener**, corresponding LED will flash. While continuing to hold that button, press and release button 1. Press and release button 1 again.
- C. Release the button being held in step B and wait for the LED to stop flashing. This button is now set. Repeat Step 2 for second Opener.

# PROGRAMMING ALADDIN CONNECT™

**NOTICE:** The Aladdin Connect® feature will NOT operate unless the light fixture is installed and operational.

Perform these steps only after opener and light fixture are fully installed, programmed and tested.

## IMPORTANT SAFETY INSTRUCTIONS

### WARNING

TO REDUCE THE RISK OF SEVERE INJURY OR DEATH, READ AND FOLLOW ALL INSTRUCTIONS.

1. Never allow children to operate or play with door controls.
2. Install the entrapment WARNING placard next to the wall control in a prominent location.
3. NO PERSONS SHOULD CROSS THE PATH OF A MOVING DOOR.
4. NEVER GO UNDER A STOPPED/PARTIALLY OPEN DOOR.
5. The Aladdin Connect™ operating system is designed for unattended operation. The door could move unexpectedly.

**SAVE THESE INSTRUCTIONS**

## CONSIGNES DE SÉCURITÉ IMPORTANTES

### AVERTISSEMENT

POUR RÉDUIRE LE RISQUE DE BLESSURES GRAVES VOIRE MORTELLES, LIRE ET COMPRENDRE TOUTES LES INSTRUCTIONS.

1. NE JAMAIS laisser les enfants utiliser ou jouer avec les commandes de l'ouvre-porte.
2. Placer l'étiquette d'AVERTISSEMENT en cas de coincement à proximité du bouton mural ou de la console murale de manière à ce qu'elle soit bien en évidence.
3. NE JAMAIS PASSER SOUS LA PORTE EN MOUVEMENT.
4. NE JAMAIS PASSER SOUS UNE PORTE À L'ARRÊT PARTIELLEMENT OUVERTE.
5. Le système d'exploitation Aladdin Connect™ a été conçu pour fonctionner sans surveillance. La porte peut se déplacer de façon inattendue.

**CONSERVER CES INSTRUCTIONS**

## Integrated Aladdin Connect™

The Aladdin Connect™ system is a convenient mobile device app to operate up to 20 garage door openers/controllers from Aladdin Connect™.

The Aladdin Connect™ app has the following features:

Up to 20 users for each account.

Sends notifications any time the garage door is operated from the app, wall console or remote control.

Show reports for opener usage showing dates and times when the opener was operated.

Show reports of who operated the opener when used from another user on the account.

Set custom RULES for predetermined times to automatically close a chosen door and/or notify of its operation.

Opener light system and an audible signal will activate as a warning that the opener is about to operate.



To use the Genie® Aladdin Connect™ app to control this garage door system follow these steps.

**Other home automation apps may also control this garage door opener system. Check our website at [www.geniecompany.com](http://www.geniecompany.com) for updates pertaining to compatible 3rd party apps.**

## 1 Check Wi-Fi Signal

**FOR ALL APPS - Use smart phone or other mobile device to check Wi-Fi signal strength.**

Hold the device near the garage door opener and check Wi-Fi meter on the device.

If signal is present, proceed to step 2 if using the Aladdin Connect™ app.

**Follow manufacturers instructions for other 3rd party apps.**

If signal is very weak or nonexistent, try the following:

Move Wi-Fi router closer to the garage.

Install a Wi-Fi range extender.

(Available at most electronics stores.)





## 2 Download the Aladdin Connect™ app (Unless using 3rd party app)

Scan for iOS app  
Versions 8 and higher



Apple and the Apple logo are trademarks of Apple Inc., registered in the U.S. and other countries. App Store is a service mark of Apple Inc.

Scan for Android app  
Versions 4.4 and higher



## 3 Follow the Aladdin Connect™ app instructions

Follow steps per the app instructions.

- Create an account
- Set up opener(s)
- Add users
- Set rules and notifications.

For help at any time contact The Genie Company at 1-866-599-4995 or visit our website. [www.geniecompany.com](http://www.geniecompany.com)

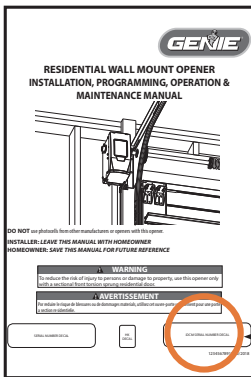

Scan the Aladdin Connect™ QR Code on the front of this manual or on the powerhead when prompted by the Aladdin Connect™ app.

## 4 Install WARNING placard

Place included unintended operation warning placard next to garage door openers wall button.

**NOTE:** This placard should be used in lieu of the standard WARNING placard included with this opener.



**NOTE:** Use of this product, the software embedded within this product and the related application software is subject to the Terms and Conditions available at: [www.geniecompany.com](http://www.geniecompany.com)

## SPECIAL INSTALLATION INFORMATION

If a 115V power outlet is not available within 5 feet from bottom of the opener when mounted to door, as an option the Alternate Low Voltage Power Kit may be used (See section 9).

This task should be performed prior to mounting opener. Fully read and understand the instructions that accompany the kit before proceeding.

### PERMANENT WIRING SHOULD BE COMPLETED BY A TRAINED ELECTRICIAN ONLY:

1. Remove two screws from bottom of cover and remove main opener cover/circuit board assembly.
2. Unplug wire harnesses from main board.
3. Unplug input power cable connector from transformer input.
4. Remove transformer from chassis.
5. Remove strain relief and pull power cable from opener.
6. Install opener per instructions on pages 6 through 9.
7. Cut power cable wires and strip insulation from power cable input harness connector end.
  - All wire connections must be made **INSIDE CHASSIS** and there must be at least 3" of new power supply line wire inside chassis.
  - Check local code for the use of conduit or other protective material.
  - Conduit, fittings/strain relief, and wire nuts are not provided.
8. Install 1/2in. NPT or other suitable connector into chassis. (Adhere to local electrical code(s) and regulations)
9. Connect permanent power input cable to harness wires using approved connectors or wire nuts (Adhere to local electrical code(s) and regulations)
10. Install ground connector to permanent power cable ground wire.
11. Install ground screw and power cable ground onto chassis.
12. Plug power input harness into transformer harness.
13. Install transformer.
14. Ensure input power cable and connections do not interfere with internal moving components.
15. Plug all harnesses into main control board and install cover assembly.
16. **DO NOT APPLY POWER AT THIS TIME.**
17. Continue installation starting on page 10.

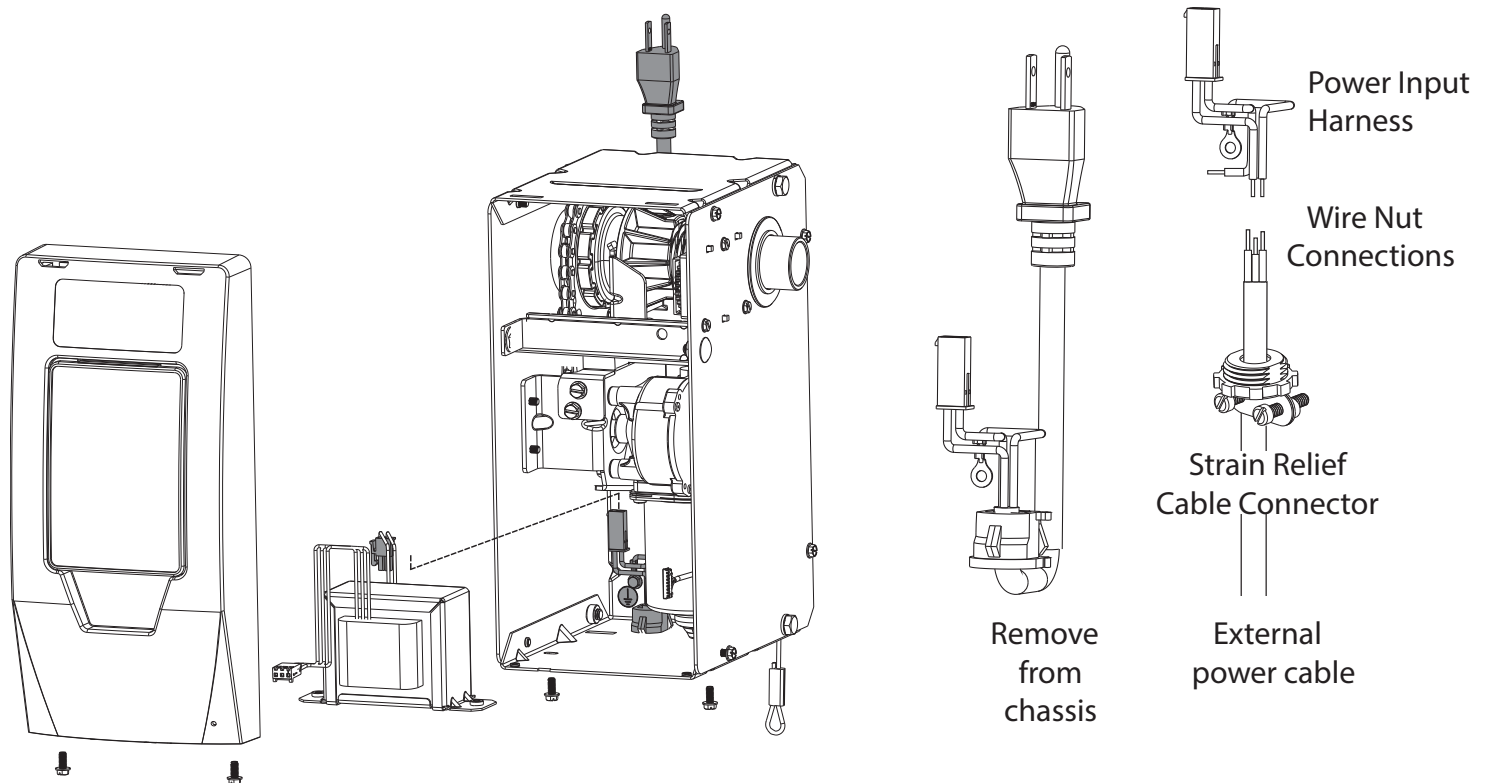

# CHANGING FORCE SETTINGS

## ⚠ WARNING

### TO AVOID INJURY OR DAMAGE

- **NEVER** adjust the force settings to adjust for damage, including an unbalanced door, binding door track or broken spring.
- Perform a CONTACT REVERSE TEST monthly.

## ⚠ AVERTISSEMENT

### Pour éviter les blessures ou des dommages

- **NE JAMAIS** régler la force pour compenser des dommages, y compris une porte mal équilibrée, un rail de porte coincant ou des ressorts cassés.
- Tous les mois, EFFECTUEZ LE TEST D'INVERSION AU CONTACT.

## ⚠ CAUTION

**DO NOT** adjust force level above what is necessary to allow for normal door operation.

## ⚠ CAUTION

NE réglez PAS la force à un niveau supérieur à ce qui est nécessaire pour permettre un fonctionnement normal de porte.

## ⚠ IMPORTANT NOTICE ⚠

**IF FORCE SETTING IS ALTERED, ALL STEPS ON PAGE 20 MUST BE PERFORMED TO LOCK IN THE FORCE PROFILE FOR PROPER DOOR OPERATION.**

### Force Settings:

Force settings are pre-programmed at the factory to force level 6 (See Chart Below) and applied during the Open/Closed Limit settings steps. For normal use, these settings should not need adjustment.

Conditions possibly requiring adjustments are:

1. Doors with very stiff weather seals.
2. Doors that start down, STOP, and reverse before closing.
3. Doors that start up, but STOP before they completely open.

1. **Press and hold** both UP & DOWN arrow buttons until the ROUND LED turns RED. Release buttons.
  - LEDs will show current force level. SEE CHART.
2. Press either the UP or DOWN arrow button until the desired **UP** force setting is shown. SEE CHART.
3. Press & release the PRGM button to lock the desired **UP** FORCE setting.
  - Both LEDs will turn BLUE then go out confirming that the UP force setting has been changed and is locked.
  - LEDs will now show the current **DOWN** FORCE setting. SEE CHART.
4. Press either the UP or DOWN arrow button until desired **DOWN** force setting is shown. SEE CHART.
5. Press & release the PRGM button to lock the desired **DOWN** FORCE setting.
  - Both LEDs will turn BLUE then go out confirming that the DOWN force setting has been changed and is locked.
6. Perform all steps on page 20 to test operator.

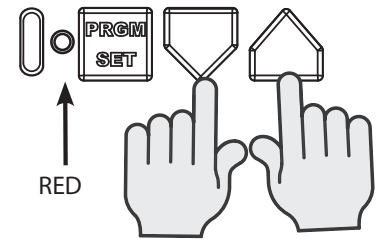

PRESS & RELEASE



See Chart for Force level indicators.

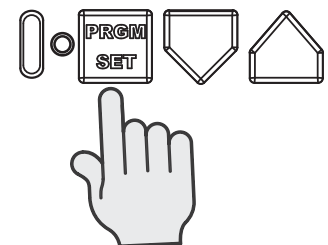

Press PRGM to lock settings

FORCE SETTING CHART		
Force Level	Long LED	Round LED
1 (LOWEST)	OFF	BLUE
2	BLUE	OFF
3	BLUE	BLUE
4	OFF	PURPLE
5	PURPLE	OFF
6	PURPLE	PURPLE
7	OFF	RED
8	RED	OFF
9 (HIGHEST)	RED	RED

# SPECIAL INSTALLATION INFORMATION

## CLEARING MEMORY OF REMOTE CONTROLS

**NOTE:** Clearing memory of remotes from the powerhead will clear ALL programmed remotes, wireless keypads and vehicle transmitters. The opener will no longer recognize any signal from any remote device, including a missing remote device. This does not include the Aladdin Connect™ or Wireless Wall Console.

All remaining (or recovered) remotes, vehicles and wireless keypads MUST be reprogrammed.

1. Press and hold the SET/PRGM button on the opener for 2-5 seconds.
  - The ROUND LED will turn BLUE. Release button.
  - The LONG LED will then flash PURPLE.
2. Press and hold the UP & DOWN buttons 2-5 seconds until both LEDs turn **BLUE** then release. Both LEDs will turn off indicating that all remotes have been erased.
3. Press any remote button. The opener should NOT run.

### 1. Enter Programming Mode

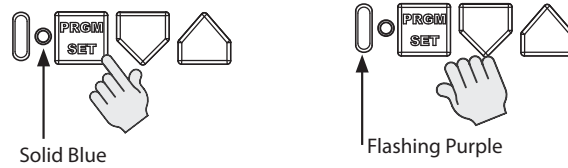

### 2. Press and Hold UP & DOWN Buttons 2-5 seconds

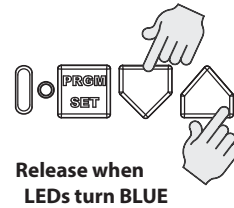

### 3. Test Remote

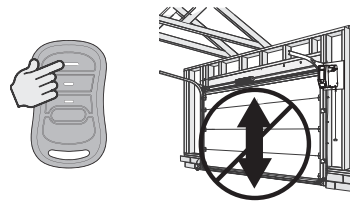

## CLEARING MEMORY OF WIRELESS WALL CONSOLE

1. Press and hold the SET/PRGM button on the opener for 2-5 seconds.
  - The ROUND LED will turn BLUE. Release button.
  - The LONG LED will then flash PURPLE.
2. Press and hold the UP & DOWN buttons 10+ seconds until both LEDs turn **GREEN** then release. Both LEDs will turn off indicating that all Wireless Wall Consoles have been erased.
3. Press WALL CONSOLE button. The opener should NOT run.

### 1. Enter Programming Mode

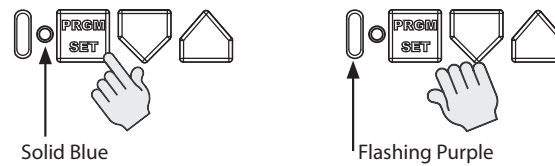

### 2. Press and Hold UP & DOWN Buttons 10+ seconds

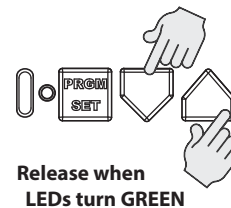

### 3. Test Wireless Wall Console



## Installing Safe-T-Beams® on multiple garage doors (Preventing “cross-talk”)

LOCATING SAFE-T-BEAM® for multiple doors  
Transmitter (RED LED) and Receiver (GREEN LED)

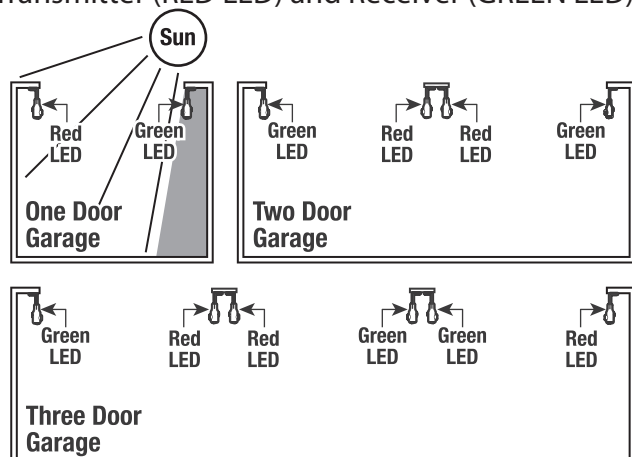

### Single Garage Door

- Determine which side of the garage receives direct sunlight.
- Position the Transmitter (Red LED) on the direct sunlight side.

### Multiple Garage Doors

- NEVER position Safe-T-Beam® modules where signals will cross.
- Place the Transmitter (Red LED) Safe-T-Beams on adjacent doors facing in opposite directions.

**NOTE:** Direct sunlight creates interference with Safe-T-Beam® Receiver (Green LED). STB modules CAN be positioned further away from the door opening if necessary to avoid sunlight but no further off the wall to maintain alignment with the Transmitter (Red LED) module.

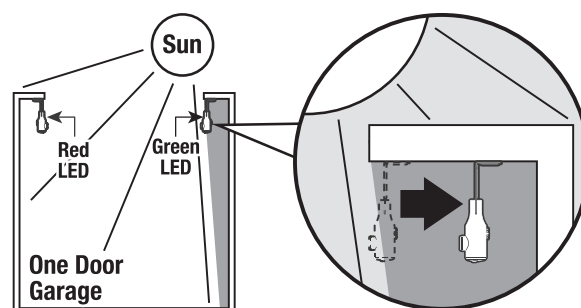

**NOTE:** Only use Safe-T-Beams® that are included with this opener. **DO NOT** use other brands or types of photocells on this opener.

## Safe-T-Beam® Self-Diagnostic Troubleshooting Chart

Source (RED LED)	Sensor (Green LED)	Possible Problem	Solution
ON	ON	Normal Operation	None Required
OFF	OFF	Opener not powered Wiring from opener bad	Check breakers, fuses, plugs Check wiring for shorts
OFF	ON	Wiring to source missing or bad Power has been interrupted	Check wiring Remove power and reapply
2 BLINKS	ON	Beam not aligned Beam obstructed Sensor defective	Check source, Sensor alignment Check for obstruction Contact Customer Support
2 BLINKS	OFF	Wire to sensor missing or bad Sensor defective	Check wiring Contact Customer Support
3 BLINKS	ON	Sensor receiving interference	Determine source of interference Contact Customer Support

## Installing the Battery Back-up (BBU)

AC power must be present to set limits. DO NOT attempt to set limits or any other programming steps from battery power only.

1. Unplug power from opener.
2. Remove two screws securing bottom cover to opener head and remove cover if applicable.
3. Plug connector of battery backup into the BBU connection on bottom of opener. Ensure connector is inserted in correct direction (SEE INSET).
4. Hold battery backup assembly at a 45 deg. angle to insert rear tabs into slots on bottom of opener.
5. Align battery backup to bottom of opener and secure with two screws removed in step 2.

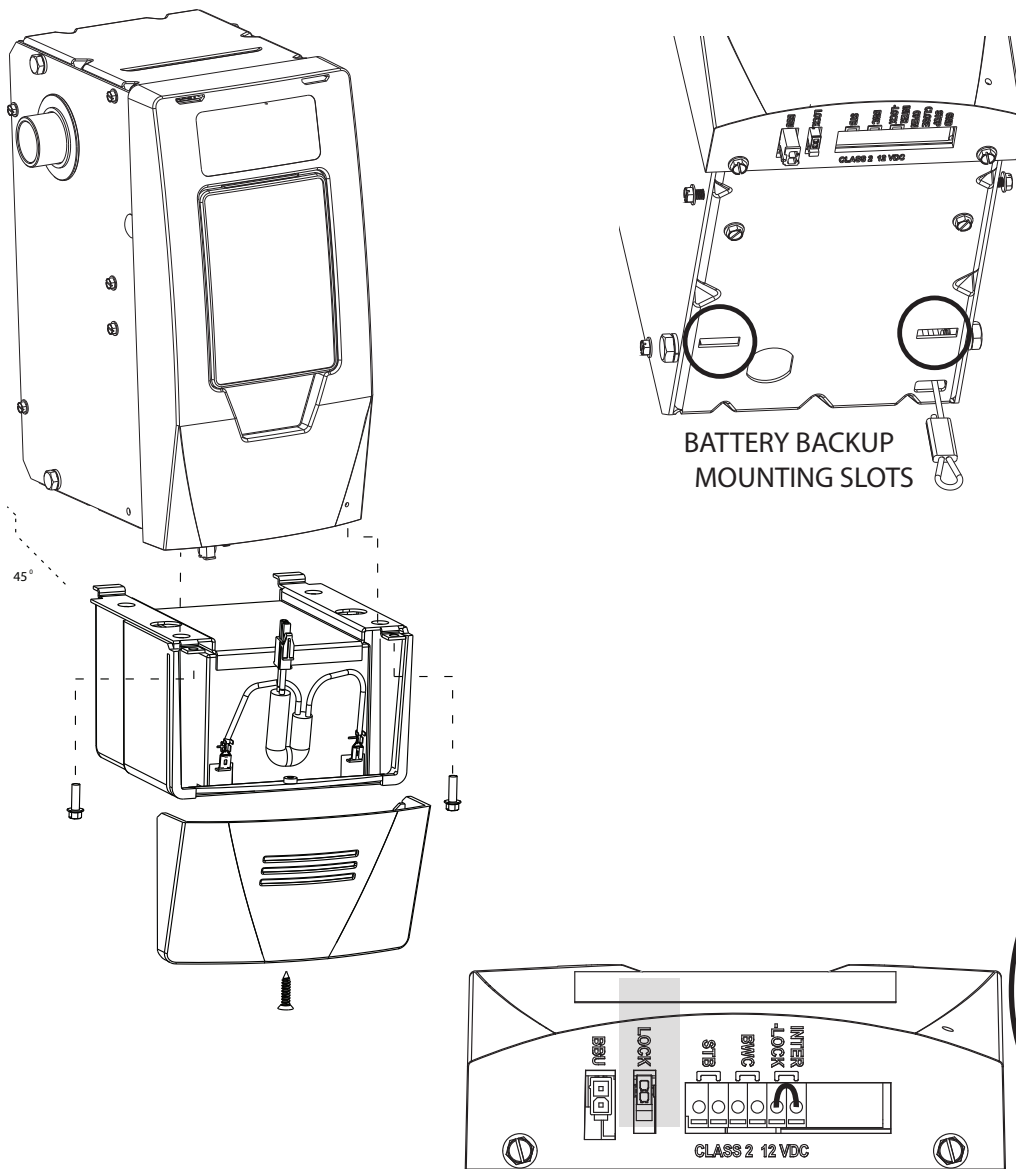

**CAUTION** TO PREVENT POSSIBLE SERIOUS INJURY or DEATH from electrocution AND REDUCE RISK of FIRE  
 — Disconnect ALL electric power sources and battery power BEFORE performing ANY service or maintenance.  
 Install only in DRY locations - NOT INTENDED FOR OUTDOOR USE.  
 Use only 12V, 5AH, SLA replacement battery (P/N 111658.0002.S).

**ATTENTION** POUR ÉVITER LES BLESSURES GRAVES VOIRE MORTELLE PAR ÉLECTROCUTION POUR RÉDUIRE ES LES RISQUES D'INCENDIE  
 — Débrancher toutes les sources d'alimentation électriques et la pile avant d'effectuer des opérations de réparation ou d'entretien.  
 Installer uniquement dans des endroits secs—NE DOIT PAS ÊTRE UTILISÉ À L'EXTÉRIEUR.  
 Utiliser uniquement une pile de remplacement de 12V, 5AH, SLA (réf. 111658.0002.S).

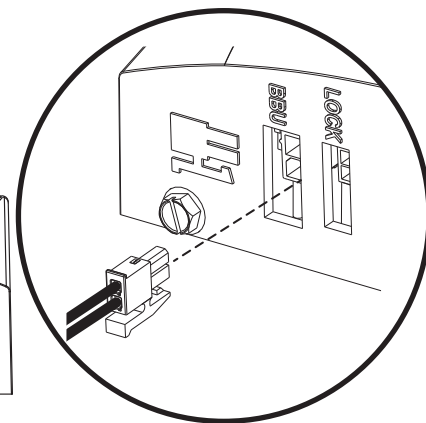

## Testing The Battery Backup

**NOTE:** It is recommended that the battery backup be allowed to charge for 24 to 48 hours prior to testing. Initially, the opener may not operate from the battery backup mode if battery is not fully charged.

1. Run the opener using the wall control or remote to ensure it is working properly.
2. Turn off power to opener by unplugging from outlet or turning off breaker.
3. Press wall control or remote control. Opener will run at a slower speed than normal.

**NOTE:** See troubleshooting guide in this manual if any of the steps above fail.

4. After successful test, reconnect powerhead to power source.

## Programming Additional Accessories

The original wireless wall console and light kits are pre-programmed from the factory. However, if adding an additional WIRELESS WALL CONSOLE or LIGHT FIXTURE to this unit or either original require reprogramming for any reason, follow the instructions below.

### • WIRELESS WALL CONSOLE

1. Press and hold the SET/PRGM button on the opener for 2-5 seconds.
  - The ROUND LED will turn BLUE. Release button.
  - The LONG LED will then flash PURPLE.
2. Press wall console main button 3 times slowly. Door should run.

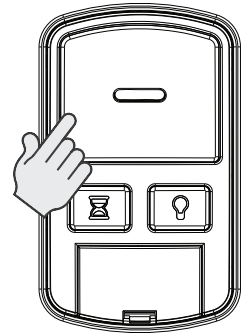

### • LIGHT FIXTURE INCLUDED WITH OPENER:

1. Power up Wall Mount Opener.
2. Power LIGHT FIXTURE.
3. LIGHT FIXTURE will flash and beep briefly.
4. LIGHT FIXTURE will flash again indicating that it is now paired to the opener.

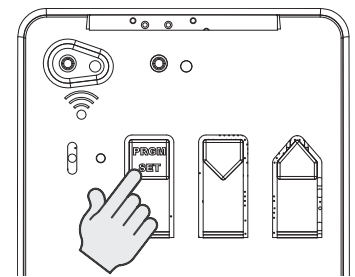

### • PAIRING LIGHT FIXTURE WITH OPENER

The light kit and opener will auto-pair upon both devices being powered up. Once paired the devices will not attempt to pair with other devices until the paired devices are cleared.

1. Ensure no other unpaired openers and light kits are powered up in the vicinity.
2. Power up opener.
3. Power up light fixture.
4. The light fixture will beep and flash briefly upon power-up followed by a longer flash to notify that it has paired with the opener.

### • CLEARING LIGHT FIXTURE PAIR FROM THE OPENER

1. Ensure no other unpaired light fixtures are powered up in the vicinity except for the light you intend to pair.
2. Press and hold the SET/PGRM button on the opener until the long LED turns green.
3. Release the SET/PGRM button.

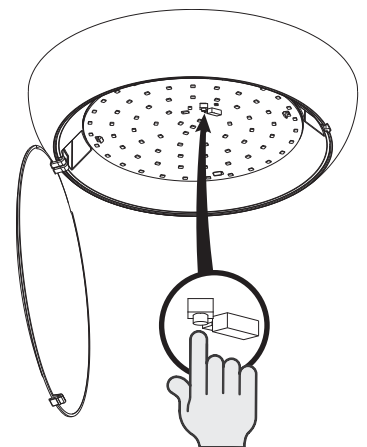

### • CLEARING OPENER PAIR FROM THE LIGHT FIXTURE

1. Ensure no other unpaired openers are powered up in the vicinity except for the opener you intend to pair.
2. Open lens cover on LED light fixture.
3. Press and hold light fixture pairing button for five seconds.
4. Release light fixture pairing button. The light fixture will beep for approximately two seconds to indicate the opener pairing has been cleared.

## ⚠ WARNING

### IMPORTANT SAFETY INSTRUCTIONS

- This portable luminaire has a polarized plug (one blade is wider than the other) as a feature to reduce the risk of electric shock. This plug will fit in a polarized outlet only one way.
- If the plug does not fit fully in the outlet, reverse the plug. If it still does not fit, contact a qualified electrician.
- Never use with an extension cord unless plug can be fully inserted.
- Do not alter the plug.

## Adding Additional Optional Accessories

### Install and Wire Basic Wall Console (Hardwired) - Optional

1. Route supplied wire from powerhead to the desired location for the hardwired wall control. Secure wire with insulated staples.
2. On the powerhead: Remove 1/4" insulation from white and striped wire. Using a small flat head screwdriver, press in the orange tab and insert the white wire into BWC WHITE terminal and the striped wire into BWC BLACK terminal.
3. At the wall console end of the wire, remove 1/4" insulation from the white and striped wires and secure the white wire to the "W" terminal and the striped wire to the "B/W" terminal as shown.
4. Mark the wall console mounting holes, drill 3/32" pilot holes and mount with #6 x 1-1/4" screws. If mounting to drywall, anchors will be required (not provided).

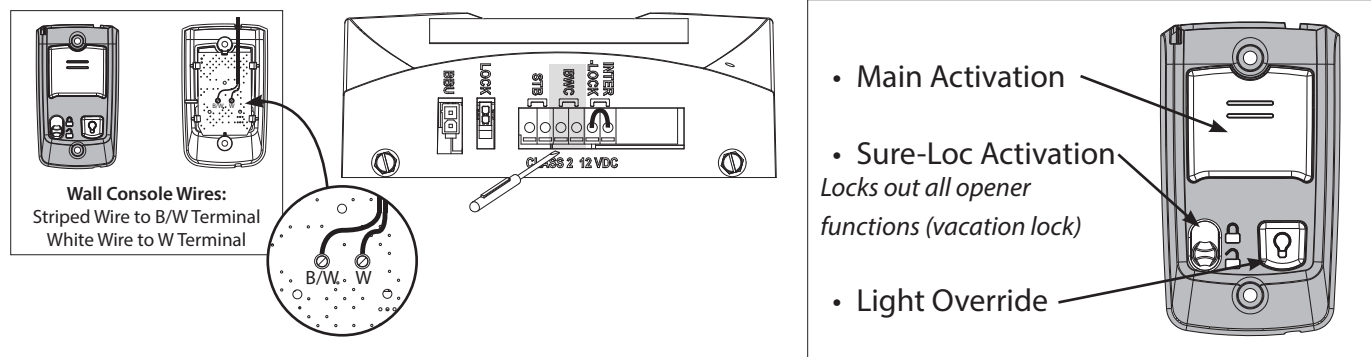

### Install and Wire N/C Interlock-Optional

1. **Do not remove factory installed interlock wire unless installing an interlock.** This jumper is required for proper opener operation.
2. Use of any commercially available normally closed (N/C) dry contact interlocks can be used with this opener. Using a small flat head screwdriver, press in the orange tabs at INTER-LOCK terminals and remove factory installed jumper wire and insert the interlock wires.

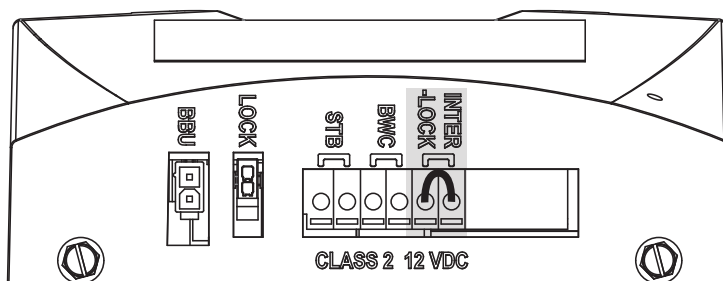





## IMPORTANT SAFETY INSTRUCTIONS

### ⚠ WARNING

**To reduce the risk of severe injury or death, read and follow all instructions.**

1. **NEVER** let children operate or play with the door controls.
2. Keep remote away from children.
3. **ALWAYS** keep the moving door in sight and away from people and objects until door is completely closed. **NO ONE SHOULD CROSS THE PATH OF THE MOVING DOOR.**
4. **NEVER GO UNDER A STOPPED, PARTIALLY OPEN DOOR.**
5. Test opener monthly. The door **MUST** reverse on contact with a 1-1/2" high object (or 2" x 4" board laid flat) at the center of the doorway on the floor. After adjusting either the force or limit of travel, retest door opener. Failure to adjust the opener properly may cause severe injury or death.
6. When possible, use emergency release only when door is closed. Use caution when using this release with the door open. Weak or broken springs are capable of increasing the rate of door closing and increasing the risk of severe injury or death.
7. **KEEP DOORS PROPERLY BALANCED.** See your garage door Owner's Manual. An improperly balanced door increases the risk of severe injury or death. Have a trained door system technician make repairs to cables, spring assemblies, and other hardware.
8. This operator system is equipped with an unattended operation feature. The door could move unexpectedly. **NO ONE SHOULD CROSS THE PATH OF THE MOVING DOOR.**

**SAVE THESE INSTRUCTIONS**

## IMPORTANTES CONSIGNES DE SÉCURITÉ

### ⚠ AVERTISSEMENT

**Pour réduire le risque de blessures graves voire mortelles, lire et comprendre toutes les instructions.**

1. **NE JAMAIS** permettre aux enfants d'actionner ou de jouer avec les commandes de la porte.
2. Tenir les télécommandes hors de la portée des enfants.
3. **TOUJOURS** garder en vue la porte en mouvement et tenir à l'écart toute personne ou objet jusqu'à ce que la porte soit totalement fermée. **PERSONNE NE DOIT TRAVERSER LA TRAJECTOIRE D'UNE PORTE EN MOUVEMENT.**
4. **NE JAMAIS PASSER SOUS UNE PORTE À L'ARRÊT PARTIELLEMENT OUVERTE.**
5. Tester l'ouvre-porte une fois par mois. La porte de garage **DOIT** inverser sa course au contact d'un objet de 4 cm (planche de 5 sur 10 cm) posé à plat sur le sol au centre de l'ouverture de la porte. Après avoir réglé la force ou la limite de la course, retenter l'ouvre-porte de garage. Un mauvais réglage de l'ouvre-porte peut entraîner des blessures graves voire mortelles.
6. Utiliser, dans la mesure du possible le déclenchement d'urgence uniquement lorsque la porte est fermée. Utiliser le déclenchement d'urgence avec prudence lorsque la porte est ouverte. Des ressorts faibles ou brisés peuvent faire descendre la porte rapidement ce qui peut entraîner des blessures graves voire mortelles.
7. **VEILLER À CE QUE LA PORTE SOIT CORRECTEMENT ÉQUILIBRÉE.** Consulter le manuel du propriétaire de la porte de garage. Une porte déséquilibrée pourrait entraîner de graves blessures voire mortelles. Demander à un technicien spécialisé en système de portes de se charger des réparations des câbles, des ressorts et de toute autre quincaillerie.
8. Ce système d'ouvre-porte est muni d'une fonction d'activation sans surveillance. La porte pourrait bouger sans que vous vous y attendiez. **IL NE FAUT JAMAIS PASSER DANS LA TRAJECTOIRE D'UNE PORTE EN MOUVEMENT.**

**CONSERVER CES INSTRUCTIONS**

### ⚠ WARNING

Use of any other wall control can cause unexpected operation of the door and loss of lighting feature. Locate wall console within sight of the door but far enough from door to prevent contacting it while operating the console. Control must be at least 5 feet above the floor to prevent small children from operating it.

### ⚠ AVERTISSEMENT

L'utilisation d'une autre commande murale pourrait produire des résultats inattendus de la porte ainsi que le dysfonctionnement de l'éclairage. Localisez la console murale en vue de la porte et suffisamment loin de la porte pour éviter tout contact pendant l'utilisation de la console. La commande doit être à une hauteur minimale de 1,5 m au-dessus du sol afin que les jeunes enfants ne puissent pas l'atteindre.

Regular inspection/maintenance for the door and opener should be performed at regular intervals to ensure the system runs at peak safety, performance and efficiency.

MAINTENANCE ITEM	INTERVALS	DETAILS
Contact Reverse Test	Monthly	See Page 20 to run system test.
Lubricate Door Hardware	Monthly	Lubricate Rollers & Hinges with a light weight general purpose grease.
Safe-T-Beam® system check	Monthly	Check wiring for loose connections, cracks or worn insulation. Clean lenses of dirt & debris.
Door Balance	Monthly	See Maintenance Detail A
Battery Backup System	Monthly	Unplug opener from outlet. Test opener with remote or wall console. Replace battery if needed.
Remote Battery replacement	As Needed	See Maintenance Detail B

## A Door Inspection

**Perform the Door inspection as follows:**

With the door closed, pull manual emergency release handle DOWN to disengage opener from door.

- Raise and lower the door manually. Door should move freely and smoothly.
- Raise door manually about 3' to 4' feet from floor and let go.. Door should remain stationary or slowly drift closed. FIG. 1.

If door opens or closes rapidly, **CONTACT A TRAINED DOOR SYSTEM TECHNICIAN** to have your door springs serviced.

- Close the door.
- Pull emergency release cord down and release quickly to engage opener to door.
- Operate door using remote or wall control.

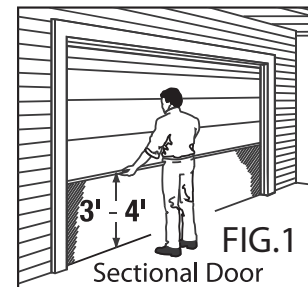

**⚠ WARNING**

Garage door hardware (springs, cables, brackets, pulleys, etc.) are under extreme pressure and tension.  
**DO NOT** attempt to repair or adjust door springs or any hardware, and **DO NOT OPERATE** garage door automatically or manually if door is improperly balanced or springs are broken.  
**CONTACT A TRAINED DOOR SYSTEM TECHNICIAN.**

**⚠ AVERTISSEMENT**

La quincaillerie de la porte de garage (ressorts, câbles, supports, poulies, etc.) sont sous des pressions et des tensions extrêmes.  
**NE PAS** réparer ni régler les ressorts de la porte ou toute autre pièce de quincaillerie et **NE PAS ACTIONNER** la porte manuellement ou automatiquement si elle n'est pas correctement équilibrée ou si des ressorts sont cassés.  
**CONTACTEZ UN TECHNICIEN SPÉCIALISÉ EN SYSTÈME DE PORTES**

## B Replacing Batteries

### Remote Battery Replacement (3-button)

Replace remote battery with a CR2232 coin cell battery.

1. Open remote case using a washer or coin that fits into the slot on the top of the remote.
2. Replace battery. Be sure positive side (+) is UP.
3. Align components and snap case closed.

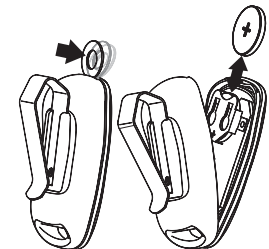

### Wall Console Battery Replacement

Replace wall console batteries with 2-AAA batteries.

1. Open remote case.
2. Replace batteries. Ensure insertion in correct position.
3. Align components and snap case closed.

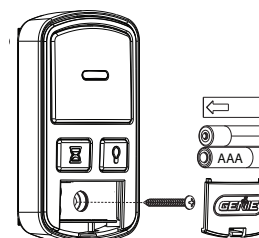



**Need help or have questions? Call Genie® at 1-800-35-GENIE or visit: [www.geniecompany.com](http://www.geniecompany.com)**

**Opener does NOT operate when wall control is pressed.**

- Replace Wireless Wall Console Batteries, see page 33.
- If applicable, turn Sure-Lock™ OFF with Basic Wall Console, see page 14.
- Check power source
- If power is OK, check connections at powerhead terminals.
- Check for reversed, broken or cut wires. Staples can cut insulation and short wires. Repair or replace.

**Opener runs, but door does not move.**

- Ensure coupler set screws have not loosened, see page 9.

**Opener works from wall control, but NOT from remote.**

- Check all remotes.
- Replace remote battery, see page 33.
- Program remotes to powerhead, see page 21.

**Remote has less than 25 feet operating range or no operation.**

- Relocate remote inside car and /or point remote at garage door.
- Replace remote battery, see page 33.
- Eliminate possible competing signals (radio, etc.).

**Door starts down, then STOPS and goes back up. OR Safe-T-Beam® System malfunction.**

- If NEW Installation, make sure ONLY the Safe-T-Beams® that came with this opener are installed.
- Check if limits are properly set, see pages 18-19. Adjust limits as needed.
- Check if Safe-T-Beam® red LED is flashing. See page 29, Safe-T-Beam® system check.
- Check Safe-T-Beam® system for beam obstruction or misalignment of lenses. See page 29, Safe-T-Beam® system.
- Check garage door for binding.
- Disconnect operator and try to manually close the door.
- If an operational problem exists, and opener will not close, the opener can be forced to close as follows:  
Press and hold the wall control button until door is completely closed.
- Check for interference from adjacent Safe-T-Beam® unit, see page 29.
- Check opener Door Lock and wire connections, see page 11.
- Contact Genie® at 1-800-35-GENIE.

## **TROUBLESHOOTING** (CONT')

### **Door starts down, then STOPS before it is closed. OR Door will only open.**

- Check Safe-T-Beam® wire connection at powerhead and at STBs. See page 12/29, Safe-T-Beam® system check.
- Check if limits are properly set, see pages 18-19. Adjust limits as needed.
- Check CONTACT REVERSE, see page 20.
- Check garage door for binding. See maintenance and adjustment. Page 33.
- Check closing "FORCE" control, see page 20, and Force settings 27.
- Check opener Door Lock and wire connections, see page 11.

### **Door starts up but STOPS before it is completely open.**

- Check if limits are properly set, see pages 18-19. Adjust limits as needed.
- Be sure door, opener, springs are in good repair, properly lubricated and balanced. Page 33.
- Disconnect operator and try to manually open the door.
- Check closing/opening "FORCE" control, see page 20, and Force settings 27.
- If you suspect a problem with the garage door hardware or springs, visit [www.geniecompany.com](http://www.geniecompany.com) and use the "dealer locator" to hire a local door service professional. NEVER try to repair door hardware or springs yourself.
- Check opener Door Lock and wire connections, see page 11.

### **Door will only run closed.**

- If applicable, turn Sure-Lock™ OFF with Basic Wall Console, see page 14.
- Check if limits are properly set, see pages 18-19.
- Check door balance, condition, and door spring, see page 33.
- Check opening "FORCE" control, see page 20, and Force settings 27.
- If you suspect a problem with the garage door hardware or springs, visit [www.geniecompany.com](http://www.geniecompany.com) and use the "dealer locator" to hire a local door service professional. NEVER try to repair door hardware or springs yourself.

### **Door opener starts for no reason.**

- Button stuck on wall control or remote.
- Was remote lost or stolen? Erase all remotes from powerhead memory and program new remotes, see page 28 and 21.

### **Noisy operation.**

- Be sure all door fasteners are tight, see page 33.
- Be sure garage door is in good repair, properly lubricated and balanced, see page 33.
- Be sure opener is in good repair.

### **Door opener runs slow.**

- Check door balance, see page 33.
- Check operating condition of door. Door may need professional repair/adjustment.

# TROUBLESHOOTING (CONT')

## POWERHEAD LEDS

Powerhead LED		Possible Problem	Solution
Round LED	Long LED		
OFF	OFF	Normal operation.	None required.
		No response from unit.	Check power supply. Contact a trained door system professional.
ON/RED/ STEADY	ON/RED/ STEADY	Limits NOT set properly.	Re-program limits, see pages 18-19.
ON/RED/ FLASHING	ON/RED/ FLASHING	Program error.	Unplug unit, wait 5 seconds, plug in.
		Component failure.	Contact a trained door system technician.
ON/BLUE/ FLASHING	OFF	Remote NOT programmed.	Program remote, see page 21.
ON/PURPLE/ FLASHING	OFF	Remote NOT programmed.	Program remote, see page 21.
ON/RED/ FLASHING	OFF	Safe-T-Beam® physical obstruction.	Remote obstruction, recheck unit.
		Safe-T-Beam® signal interference.	Check alignment of Safe-T-Beam® pair and nearest other Safe-T-Beam® pair, see page 29.
OFF	ON/RED/ FLASHING	Door contact in UP or DOWN travel.	Remove obstruction.
		Door component failure detected.	Check door spring, track, rollers, hinges and fixtures.
OFF	ON/RED/ STEADY	Thermal cutout.	DO NOT unplug unit. Wait until LED clears before operating.
PULSING RED FLASH		Interlock Open	Check missing wire from interlock terminal Inspect interlock (see page 14)
ON/PURPLE/ STEADY	ON/PURPLE/ STEADY	Component error.	Contact a trained door system technician.
OFF	ON/BLUE/ FLASHING	Door will not open.	Check Sure-Lock™. Sure-Lock™ should be OFF for normal operation (see page 14).
ON/PURPLE/ FLASHING	ON/PURPLE/ FLASHING	Radio receiver error.	Unplug the unit. Wait 5 seconds and plug the unit back in. If problems persist, contact a trained door system technician.
<b>LED SIGNALS with BATTERY BACK-UP installed</b>			
ON/GREEN STEADY	ON/GREEN STEADY	OK= Normal Operation. Charged, Battery Back Up	None Required
ON/GREEN FLASHING	ON/GREEN FLASHING	Discharging, Battery Back Up	Power is out. Battery in use.
ON/YELLOW FLASHING	ON/YELLOW FLASHING	Charging, Battery Back Up	None Required
ON/RED TO YELLOW FLASHING	ON/RED TO YELLOW FLASHING	Dead Battery, Battery Back Up	Replace Battery.

## PARTS, SERVICE & ACCESSORIES

Specify model number of opener when ordering parts

DESCRIPTION	PART NUMBER
Hardware Bag	39946R.S
Cable Keeper Kit	39794A.S
Coupler	39830R.S
Door Lock	40760R.S
Door lock harness	40629A.S
Wireless Wall Console	39815R.S
Light Fixture	39945R.S
Low Voltage Power Input Kit	40984R.S
TorqueMaster® Adapter Kit	41032R.S
Alternate Mounting Kit	40803R.S

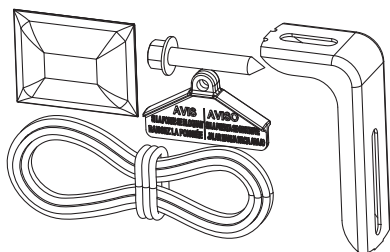

Hardware Bag

- Staples
- Lag Bolt
- Mounting Bracket
- Emergency Release Cord
- Emergency Release Handle

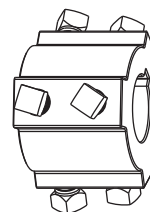

Coupler

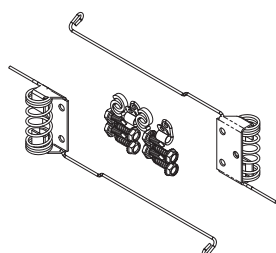

Cable Keeper Kit



Wireless Wall Console

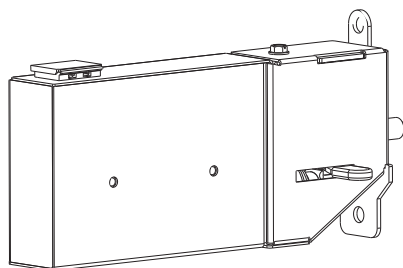

Door Lock

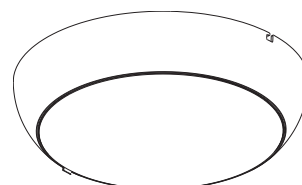

BlueTooth LED  
LIGHT FIXTURE

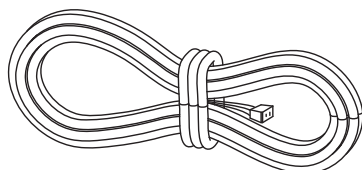

Door Lock Harness

## REPLACEMENT PARTS

**Specify model number of opener when ordering parts**

ITEM	DESCRIPTION	QTY
1	Housing Cover	1
2	Main Control Board Kit	1
3	Integrated Aladdin Connect® Control Board Kit	1
4	Transformer Kit	1
5	Chain assembly, 16 Loop, 1/2" P	1
6	Shaft Assembly Kit	1
7	Motor Assembly Kit	1
8	MLS (Travel Limit) Kit	1
9	Release Assembly Kit	1
10	Side Panel Assembly RH	1
11	Side Panel Assembly LH	1
12	Bottom Cover	1
13	Center Brace	1
14	Battery Backup Battery	1
15	Battery Backup housing	1



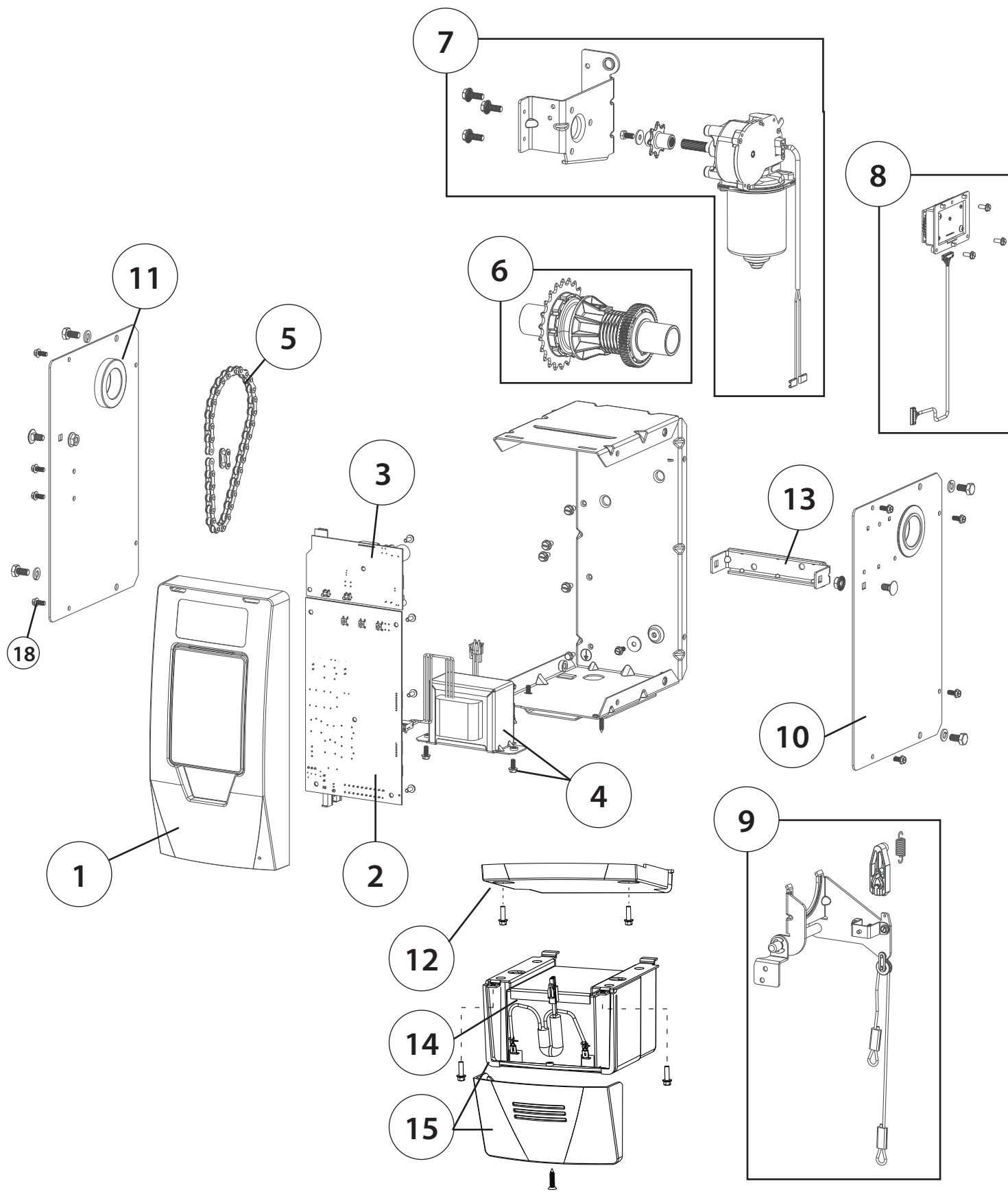



Look for this Safety Alert Symbol below. This symbol indicates a potential personal safety hazard that can result in injury or death.

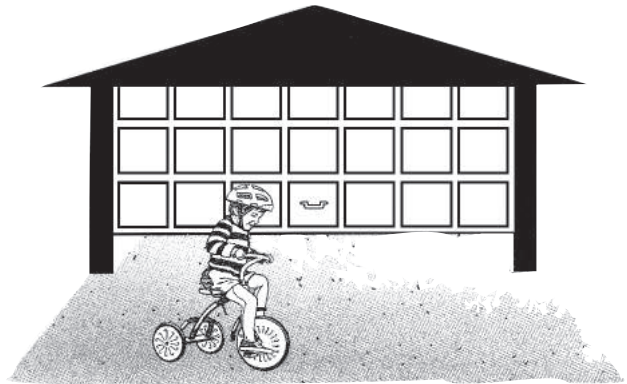

### A GARAGE DOOR IS THE LARGEST MOVING OBJECT IN THE HOME.

These doors are often operated by electric door openers. Proper installation, operation, maintenance, and testing of the garage door and automatic opener are necessary to provide safe, trouble-free operation.

An improperly adjusted garage door or automatic opener can exert deadly force when the door closes. This could lead to serious injury or death from being hit by a closing garage door or from being trapped under the door.



A few simple precautions can protect our family and friends from potential harm. Please take a few minutes to read the following safety and maintenance tips. Refer to your garage door and opener owner's manual for details specific to your garage door and automatic opener.



Do not stand or walk under a moving door! Do not let children or adults play "beat the door."

It is dangerous and can result in serious injury or death. Adults should set a good example. Know how to use the emergency release, in case someone is pinned by the door.



Do not let children play with or use the transmitters or remote controls. Always place or store them out of the reach of children.

children.



## DASMA SAFETY GUIDELINES (CONT')



**The push button wall control should be out of reach of children.**

(at least 5 feet from the floor) and away from all moving parts. Mount and use the button where you can clearly see the moving garage door.



**GARAGE DOOR OPENERS ARE NOT TOYS.**

Careless operation and allowing children to play with or use garage door opener controls can lead to tragic results. Discuss garage door safety with your children. Explain the danger of being trapped under the door.

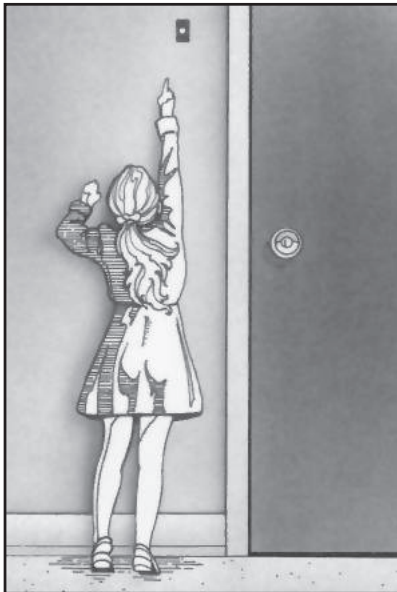

**WHEN USING THE PUSH BUTTON OR TRANSMITTER, KEEP THE DOOR IN SIGHT UNTIL IT COMPLETELY STOPS MOVING.**

Teach children never to play under or near an open garage door.

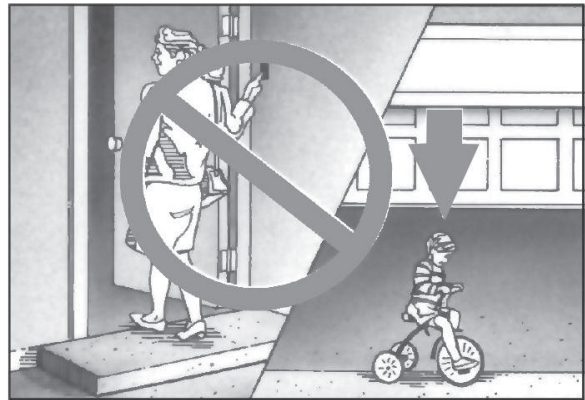

**Teach children to keep their hands and fingers clear of section joints, hinges, track, springs, and other door parts.**

Contact with a moving door or its hardware could cause injury. These injuries can also happen with garage doors that don't have automatic openers.



**National  
Safety  
Council**

This important information is provided by the U.S. Consumer Product Safety Commission, the National Safety Council, and the Industry Coalition for Automatic Garage Door Opener Safety.

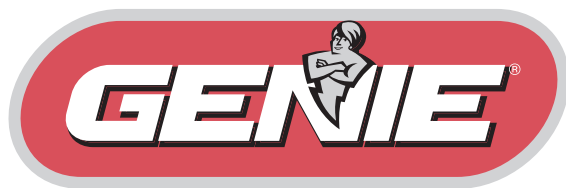

**The Genie Company**  
**1 Door Drive, Mount Hope OH. 44666**  
**1-800-35-GENIE**  
**[www.geniecompany.com](http://www.geniecompany.com)**

DOOR LOCK TEMPLATE